

YDS-USB3A-AF-IMX258 V1.0**13MP Sony IMX258 Auto Focus USB 2.0 Camera Module**

YDS-USB3A-AF-IMX258 V1.0 is a 13MP Auto Focus USB camera module based on 1/3.06" IMX258 image sensor. Auto Focus captures images clearly at different distances. It delivers high-speed, 4K resolution ultra sharp image.

The camera has a dedicated, high-performance auto focus function providing best-in-class image and video output. This camera module is ideal solution for drones, automotive, agriculture farming, medical equipment, and traffic monitoring.

Key Features

- 4K resolution (4224 x 3192) Sony IMX258 sensor
- High speed USB 2.0 Plug and Play
- MJPG output format
- Low power consumption
- Compact size
- UVC compliant to Windows, Linux, OS with UVC driver
- USB OTG (On-The-Go) support



YDS CAMERA MODULE

your best camera partner

YDS-USB3A-AF-IMX258 V1.0

13MP Sony IMX258 Auto Focus USB 2.0 Camera Module

Camera Module No.	YDS-USB3A-AF-IMX258 V1.0
Resolution	13MP
Image Sensor	IMX258
Sensor Type	1/3.06"
Pixel Size	1.12 um x 1.12 um
EFL	3.81 mm
F.NO	2.20
Pixel	4224 x 3136
View Angle	74.4°(DFOV) 62.7°(HFOV) 48.7°(VFOV)
Lens Dimensions	8.50 x 8.50 x 5.40 mm
Module Type	Auto Focus
Lens Model	YDS-LENS-50013A1
Interface	USB 2.0
Output Format	MJPEG
Auto Control	Saturation, Contrast, Acutance White Balance, Exposure
Audio	None
Input Voltage	DC 5V
Working Current	Max 500mA
PCB Size	38mm x 38mm
System Compatibility	Windows XP (SP2, SP3), Vista, 7, 8, 10, 11 Android, Mac OS, Linux or OS with UVC Driver Raspberry Pi by USB Port
Software for USB Camera	AMCAP, Webcam Viewer, V4L2 Controls Contacam, VLC Player, MotionEye OS iSpy, ZoneMider, Yawcam
Lens Type	650nm IR Cut
Operating Temperature	-20°C to +70°C
USB Cable	YDS-Cable-U006

Wide Compatibility with Windows, Android, Mac OS, Linux, or Raspberry Pi



www.YDSCAM.com sales@ydscam.com Phone (WeChat, QQ): (+86) 177 2732 6718

All rights reserved @ YingDeShun Co. Ltd. Specifications subject to change without notice.



YDS-USB3A-AF-IMX258 V1.0 13MP Sony IMX258 Auto Focus USB 2.0 Camera Module

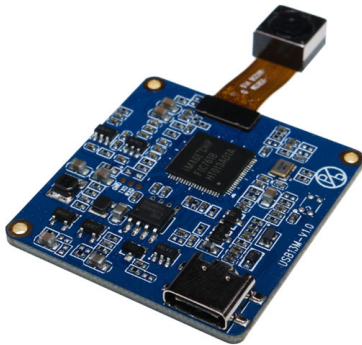

Top View



Side View



Bottom View



Mating Connector

YDS-USB3A-AF-IMX258 V1.0

13MP Sony IMX258 Auto Focus USB 2.0 Camera Module

FORMAT	RESOLUTION	FRAME RATE
		USB 2.0
MJPEG	320 x 240	25 FPS
	640 x 480 (VGA)	25 FPS
	800 x 600	25 FPS
	1024 x 768	25 FPS
	1280 x 720 (720P)	25 FPS
	1600 x 1200	25 FPS
	1920 x 1080 (1080P)	25 FPS
	2592 x 1944 (5MP)	10 FPS
	3264 x 2448 (8MP)	10 FPS
	3840 x 2160	10 FPS
4192 x 3104	10 FPS	





YDS CAMERA MODULE

your best camera partner

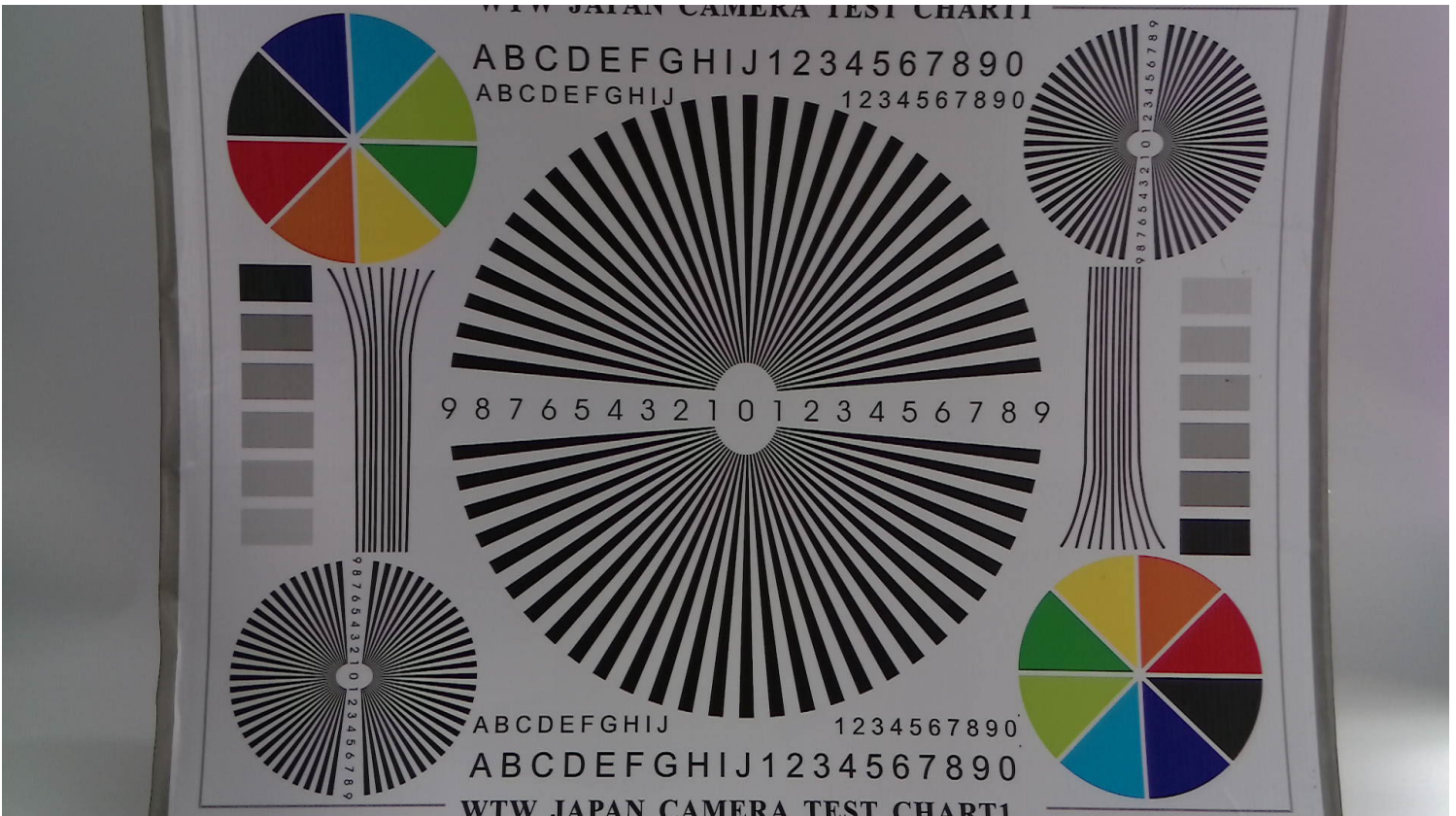
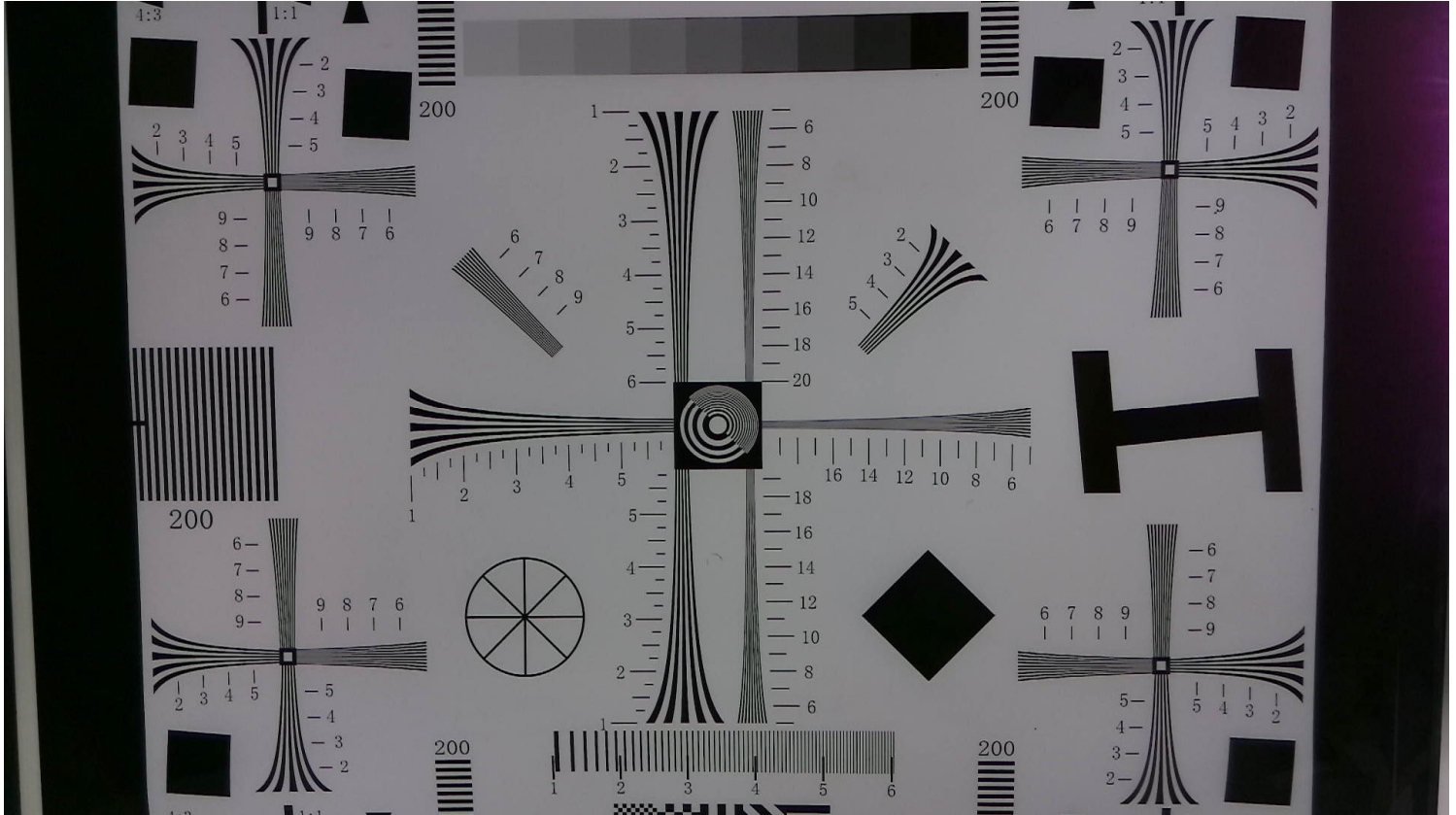

www.YDSCAM.com sales@ydscam.com Phone (WeChat, QQ): (+86) 177 2732 6718

All rights reserved @ YingDeShun Co. Ltd. Specifications subject to change without notice.



YDS CAMERA MODULE

your best camera partner

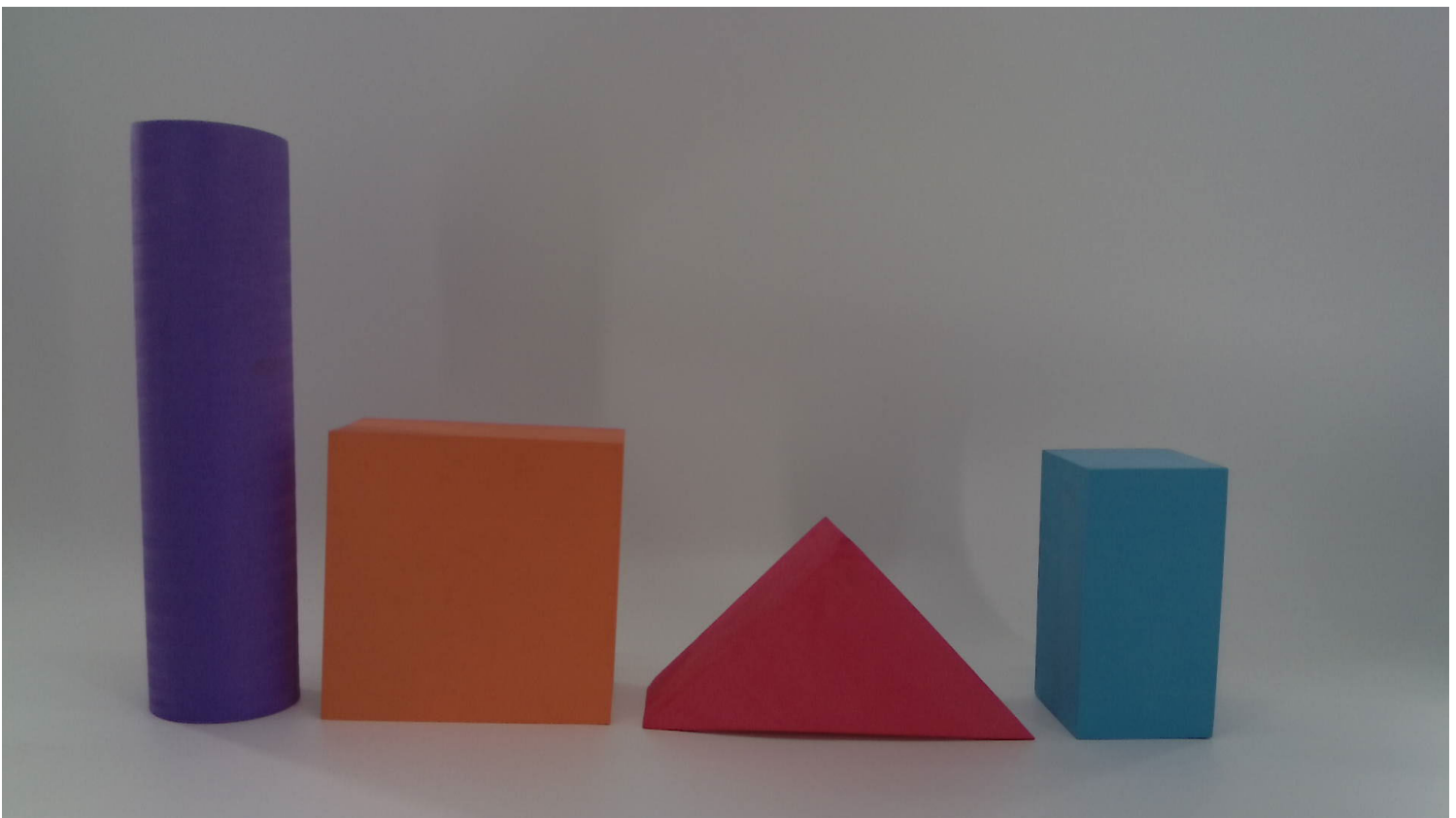
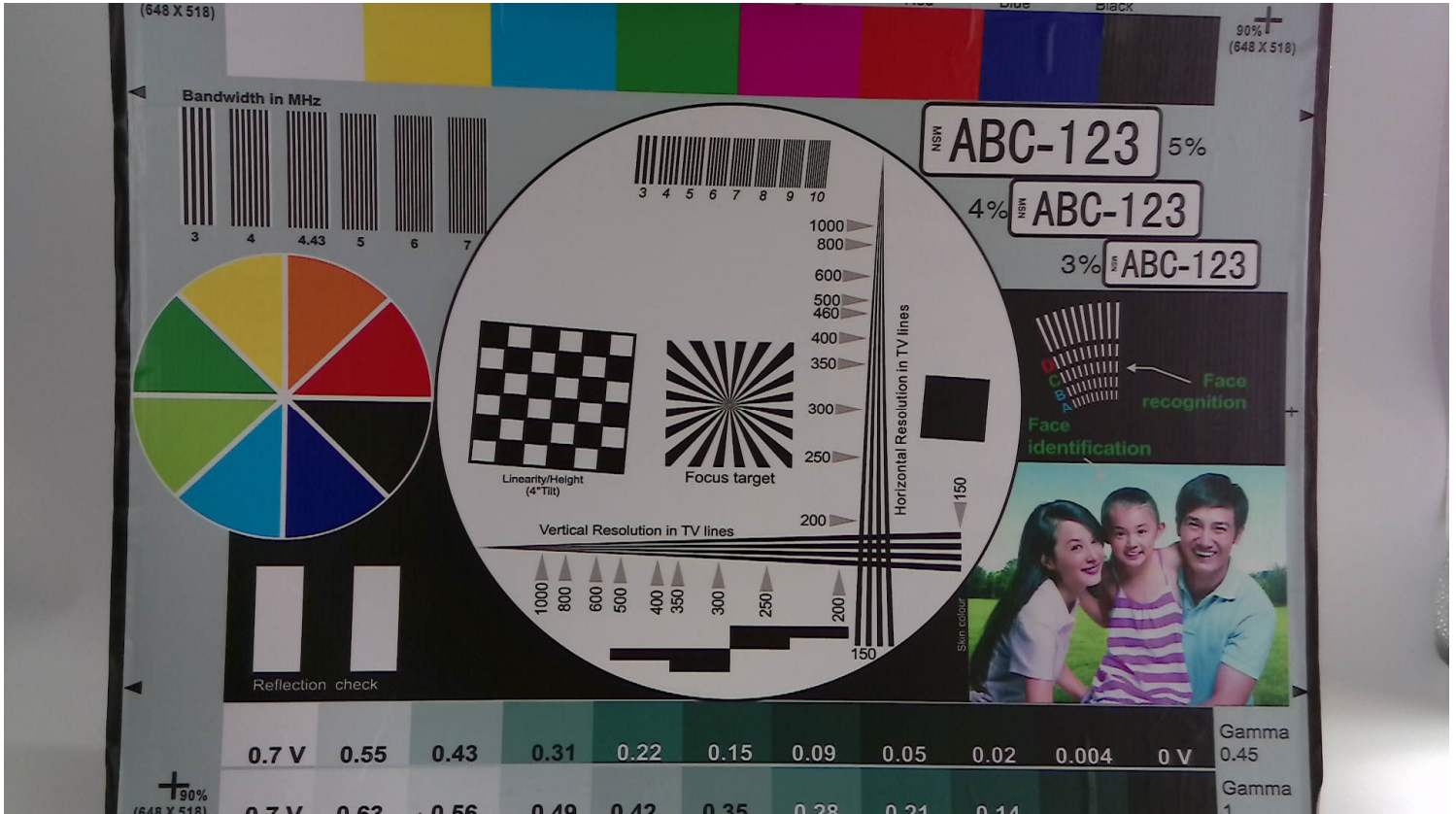

www.YDSCAM.com sales@ydscam.com Phone (WeChat, QQ): (+86) 177 2732 6718

All rights reserved @ YingDeShun Co. Ltd. Specifications subject to change without notice.

ROHS

A1	GND	B12	GND
A4	VBUS	B9	VBUS
A5	CC1	B8	SBU2
A6	DP1	B7	DN2
A7	DN1	B6	DP2
A8	SBU1	B5	CC2
A9	VBUS	B4	VBUS
A12	GND	B1	GND
PIN	SIGNAL NAME	PIN	SIGNAL NAME

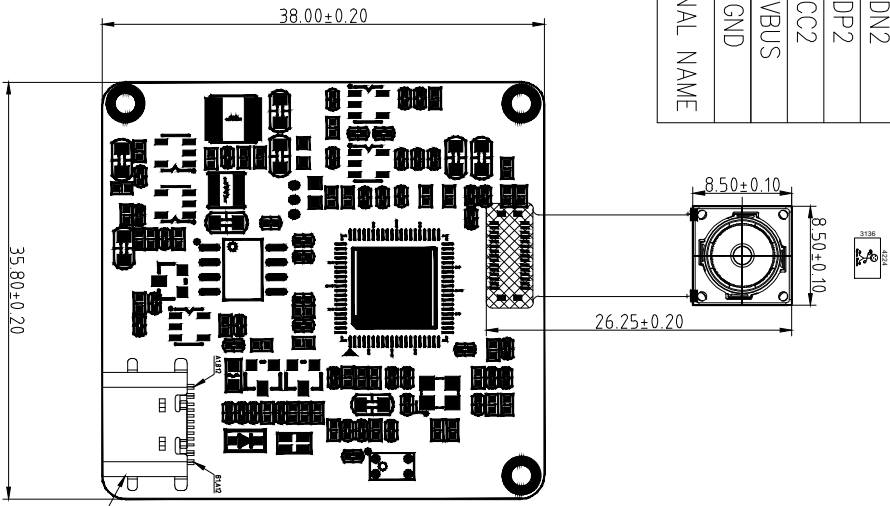

TOP VIEW

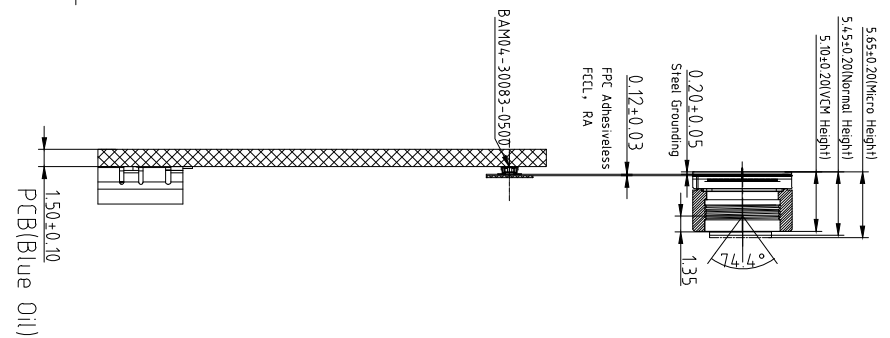

SIDE VIEW

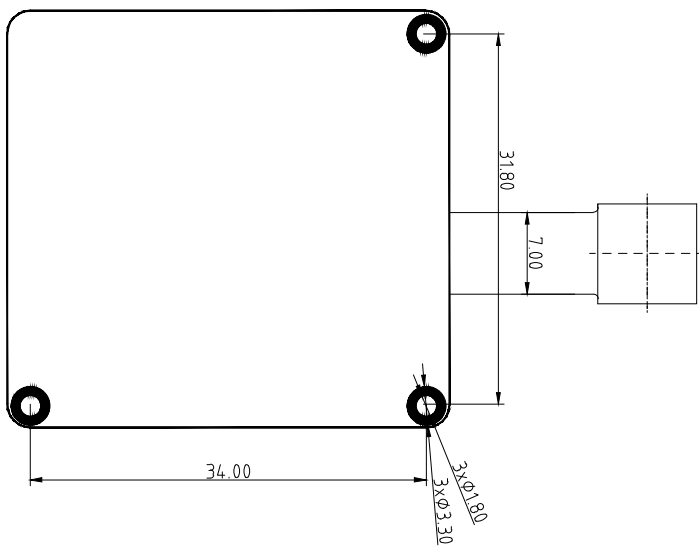

BOTTOM VIEW

Parameters:

1、Sensor specification:

Image Sensor: IMX258
 Pixel: 1.12umx1.12um
 Lens Type: 1/3.06
 Important Voltage Description:
 DVDD1.2V (external power supply);

2、Lens specification:

FOV: 74.4°
 F/NO.: 2.2
 TV distortion: <1.5%
 Focal length: 3.81mm
 Composition: 5P+IR FILTER
 IR Cut Coating: 650nm±10nm@50%

Version Mark	Information	Date
V1.0	PD First Version	11-29-2019

Designed By	Kevin	Model Name:	USB3A-AF-IMX258 V1.0		
Checked By	Aouly Yan	Projection Type:	Unit: mm	Material: -----	Scale: 1:1
		Third Angle	Sheet: 1 of 1	Version: 1/0	

[Product Brief]

Ver.1.0

IMX258

Diagonal 5.867 mm (Type 1/3.06) 13Mega-Pixel CMOS Image Sensor with Square Pixel for Color Cameras

Description

IMX258 is a diagonal 5.867mm (Type 1/3.06) 13 Mega-pixel CMOS active pixel type stacked image sensor with a square pixel array. It adopts Exmor R^{STM} technology to achieve high speed image capturing by column parallel A/D converter circuits and high sensitivity and low noise image (comparing with conventional CMOS image sensor) through the backside illuminated imaging pixel structure. R, G, and B pigment primary color mosaic filter is employed. By introducing spatially multiplexed exposure technology, high dynamic range still pictures and movies are achievable. It

equips an electronic shutter with variable integration time. It operates with three power supply voltages: analog 2.7 V, digital 1.2 V and 1.8 V for input/output interface and achieves low power consumption.

In addition, this product is designed for use in cellular phone and tablet pc. When using this for another application, Sony does not guarantee the quality and reliability of product. Therefore, don't use this for applications other than cellular phone and tablet pc. Consult your Sony sales representative if you have any questions.

Functions and Features

- ◆ Back-illuminated and stacked CMOS image sensor Exmor R^{STM}
- ◆ Phase Detection pixel data output for Phase Detection Auto Focus
- ◆ High Dynamic Range (HDR) mode with raw data output.
- ◆ High signal to noise ratio (SNR).
- ◆ Full resolution @30fps (Normal / HDR). 4K2K @30fps (Normal / HDR) 1080p @60fps (Normal)
- ◆ Output video format of RAW10/8.
- ◆ Pixel binning readout and V sub-sampling function.
- ◆ Independent flipping and mirroring.
- ◆ CSI-2 serial data output (MIPI 2lane/4lane, Max. 1.3Gbps/lane, D-PHY spec. ver. 1.1 compliant)
- ◆ 2-wire serial communication.
- ◆ Two PLLs for independent clock generation for pixel control and data output interface.
- ◆ Dynamic Defect Pixel Correction.
- ◆ Fast mode transition. (on the fly)
- ◆ Dual sensor synchronization operation.
- ◆ 4K bit of OTP ROM for users.
- ◆ Built-in temperature sensor.

Device Structure

- ◆ CMOS image sensor
- ◆ Image size : Diagonal 5.867 mm (Type 1/3.06)
- ◆ Total number of pixels : 4224 (H) × 3192 (V) approx. 13.48 M pixels
- ◆ Number of effective pixels : 4224 (H) × 3144 (V) approx. 13.28 M pixels
- ◆ Number of active pixels : 4208 (H) × 3120 (V) approx. 13.13 M pixels
- ◆ Chip size : 5.990 mm (H) × 3.908 mm (V)
- ◆ Unit cell size : 1.12 μm (H) × 1.12 μm (V)
- ◆ Substrate material : Silicon

System block diagram

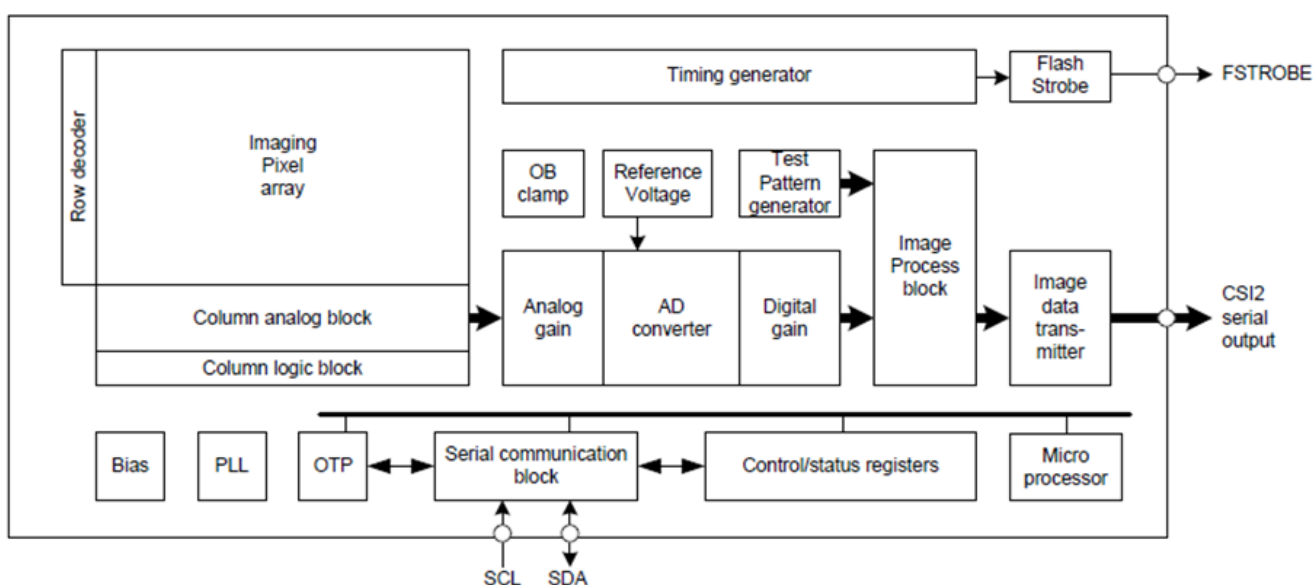

Exmor RS

* Exmor RS is a trademark of Sony Corporation. The Exmor RS is a Sony's CMOS image sensor with high-resolution, high-performance and compact size by replacing a supporting substrate in Exmor R™ which changed fundamental structure of Exmor™ pixel adopted column parallel A/D converter to back-illuminated type, with layered chips formed signal processing circuits.

YDS-LENS-50013A1

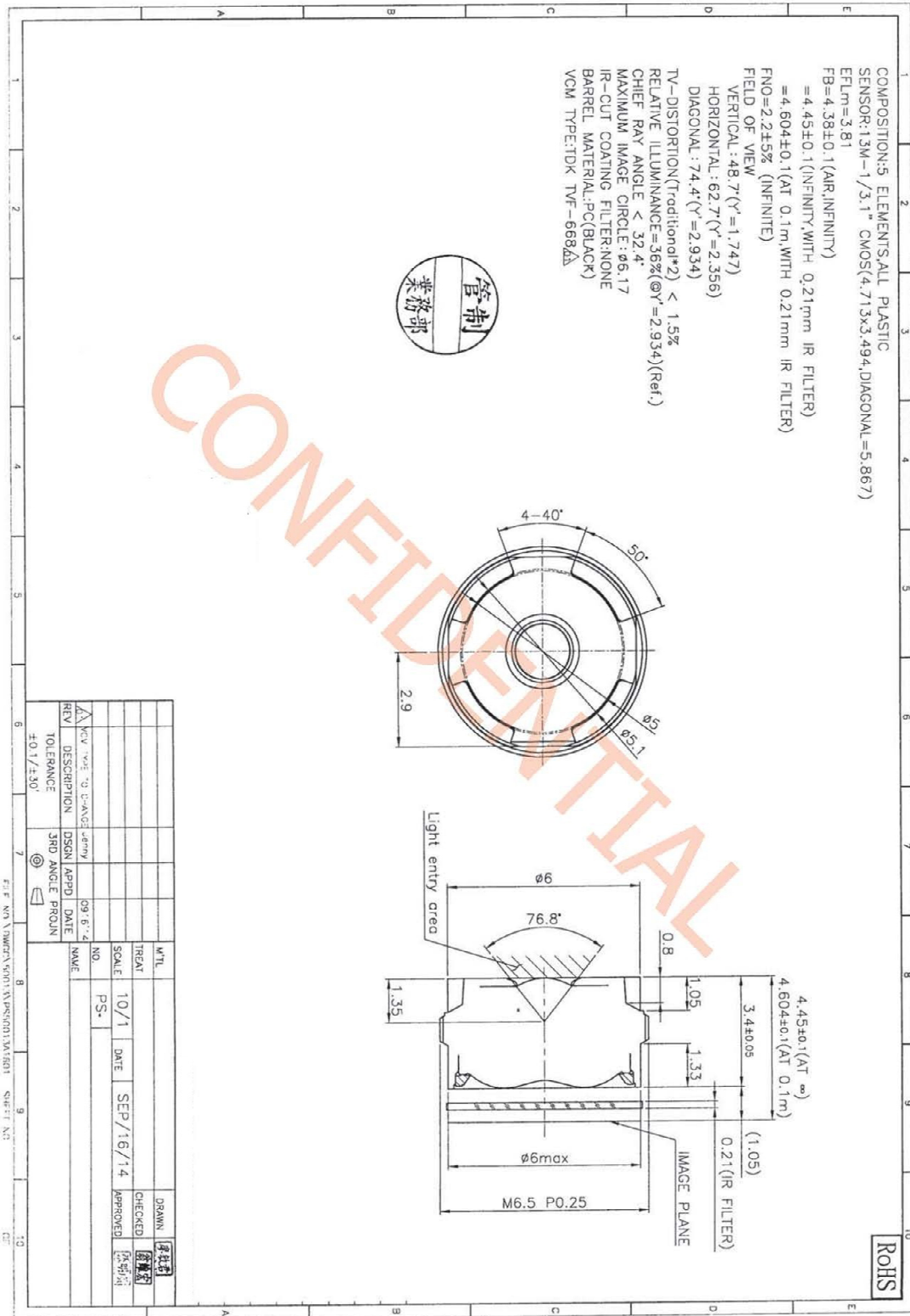



YDS CAMERA MODULE

your best camera partner

Camera Module Pinout Definition Reference Chart

OmniVision	Sony	Samsung	On-Semi	Aptina	Himax	GalaxyCore	PixArt	SmartSens	Sensors
Pin Signal		Description							
DGND GND		ground for digital circuit							
AGND		ground for analog circuit							
PCLK DCK		DVP PCLK output							
XCLR PWDN XSHUTDOWN STANDBY		power down active high with internal pull-down resistor							
MCLK XVCLK XCLK INCK		system input clock							
RESET RST		reset active low with internal pull-up resistor							
NC NULL		no connect							
SDA SIO_D SIOD		SCCB data							
SCL SIO_C SIOC		SCCB input clock							
VSYNC XVS FSYNC		DVP VSYNC output							
HREF XHS		DVP HREF output							
DOVDD		power for I/O circuit							
AFVDD		power for VCM circuit							
AVDD		power for analog circuit							
DVDD		power for digital circuit							
STROBE FSTROBE		strobe output							
FSIN		synchronize the VSYNC signal from the other sensor							
SID		SCCB last bit ID input							
ILPWM		mechanical shutter output indicator							
FREQ		frame exposure / mechanical shutter							
GPIO		general purpose inputs							
SLASEL		I2C slave address select							
AFEN		CEN chip enable active high on VCM driver IC							
MIPI Interface									
MDN0 DN0 MD0N DATA_N DMO1N		MIPI 1st data lane negative output							
MDP0 DP0 MD0P DATA_P DMO1P		MIPI 1st data lane positive output							
MDN1 DN1 MD1N DATA2_N DMO2N		MIPI 2nd data lane negative output							
MDP1 DP1 MD1P DATA2_P DMO2P		MIPI 2nd data lane positive output							
MDN2 DN2 MD2N DATA3_N DMO3N		MIPI 3rd data lane negative output							
MDP2 DP2 MD2P DATA3_P DMO3P		MIPI 3rd data lane positive output							
MDN3 DN3 MD3N DATA4_N DMO4N		MIPI 4th data lane negative output							
MDP3 DP3 MD3P DATA4_P DMO4P		MIPI 4th data lane positive output							
MCN CLKN CLK_N DCKN		MIPI clock negative output							
MCP CLKP MCP CLK_P DCKN		MIPI clock positive output							
DVP Parallel Interface									
D0 DO0 Y0		DVP data output port 0							
D1 DO1 Y1		DVP data output port 1							
D2 DO2 Y2		DVP data output port 2							
D3 DO3 Y3		DVP data output port 3							
D4 DO4 Y4		DVP data output port 4							
D5 DO5 Y5		DVP data output port 5							
D6 DO6 Y6		DVP data output port 6							
D7 DO7 Y7		DVP data output port 7							
D8 DO8 Y8		DVP data output port 8							
D9 DO9 Y9		DVP data output port 9							
D10 DO10 Y10		DVP data output port 10							
D11 DO11 Y11		DVP data output port 11							

www.YDSCAM.com sales@ydscam.com Phone (WeChat, QQ): (+86) 177 2732 6718

All rights reserved @ YingDeShun Co. Ltd. Specifications subject to change without notice.

Cameras Applications



Camera Reliability Test

Reliability Inspection Item		Testing Method	Acceptance Criteria	
Category	Item			
Environmental	Storage Temperature	High 60°C 96 Hours	Temperature Chamber	No Abnormal Situation
		Low -20°C 96 Hours	Temperature Chamber	No Abnormal Situation
	Operation Temperature	High 60°C 24 Hours	Temperature Chamber	No Abnormal Situation
		Low -20°C 24 Hours	Temperature Chamber	No Abnormal Situation
	Humidity	60°C 80% 24 Hours	Temperature Chamber	No Abnormal Situation
	Thermal Shock	High 60°C 0.5 Hours Low -20°C 0.5 Hours Cycling in 24 Hours	Temperature Chamber	No Abnormal Situation
Physical	Drop Test (Free Falling)	Without Package 60cm	10 Times on Wood Floor	Electrically Functional
		With Package 60cm	10 Times on Wood Floor	Electrically Functional
	Vibration Test	50Hz X-Axis 2mm 30min	Vibration Table	Electrically Functional
		50Hz Y-Axis 2mm 30min	Vibration Table	Electrically Functional
		50Hz Z-Axis 2mm 30min	Vibration Table	Electrically Functional
	Cable Tensile Strength Test	Loading Weight 4 kg 60 Seconds Cycling in 24 Hours	Tensile Testing Machine	Electrically Functional
Electrical	ESD Test	Contact Discharge 2 KV	ESD Testing Machine	Electrically Functional
		Air Discharge 4 KV	ESD Testing Machine	Electrically Functional
	Aging Test	On/Off 30 Seconds Cycling in 24 Hours	Power Switch	Electrically Functional
	USB Connector	On/Off 250 Times	Plug and Unplug	Electrically Functional



Camera Inspection Standard

Inspection Item		Inspection Method	Standard of Inspection		
Category	Item				
Appearance	FPC/ PCB	Color	The Naked Eye	Major Difference is Not Allowed.	
		Be Torn/Chopped	The Naked Eye	Copper Crack Exposure is Not Allowed.	
		Marking	The Naked Eye	Clear, Recognizable (Within 30cm Distance)	
	Holder	Scratches	The Naked Eye	The Inside Crack Exposure is Not Allowed	
		Gap	The Naked Eye	Meet the Height Standard	
		Screw	The Naked Eye	Make Sure Screws Are Presented (If Any)	
		Damage	The Naked Eye	The Inside Crack Exposure is Not Allowed	
	Lens	Scratch	The Naked Eye	No Effect On Resolution Standard	
		Contamination	The Naked Eye	No Effect On Resolution Standard	
		Oil Film	The Naked Eye	No Effect On Resolution Standard	
		Cover Tape	The Naked Eye	No Issue On Appearance.	
	Function	Image	No Communication	Test Board	Not Allowed
			Bright Pixel	Black Board	Not Allowed In the Image Center
Dark Pixel			White board	Not Allowed In the Image Center	
Blurry			The Naked Eye	Not Allowed	
No Image			The Naked Eye	Not Allowed	
Vertical Line			The Naked Eye	Not Allowed	
Horizontal Line			The Naked Eye	Not Allowed	
Light Leakage			The Naked Eye	Not Allowed	
Blinking Image			The Naked Eye	Not Allowed	
Bruise			Inspection Jig	Not Allowed	
Resolution			Chart	Follows Outgoing Inspection Chart Standard	
Color			The Naked Eye	No Issue	
Noise			The Naked Eye	Not Allowed	
Corner Dark			The Naked Eye	Less Than 100px By 100px	
Color Resolution			The Naked Eye	No Issue	
Dimension	Height	The Naked Eye	Follows Approval Data Sheet		
	Width	The Naked Eye	Follows Approval Data Sheet		
	Length	The Naked Eye	Follows Approval Data Sheet		
	Overall	The Naked Eye	Follows Approval Data Sheet		

YDSCAM Package Solutions

YDS Camera Module



Complete with Lens Protection Film



Tray with Grid and Space



Place Cameras on the Tray



YDSCAM Package Solutions

Full Tray of Cameras



Cover Tray with Lid



Place Tray into Anti-Static Bag



Vacuum the Anti-Static Bag



YDSCAM Package Solutions

Sealed Vacuum Anti-Static Bag with Labels

1. Model and Description 2. Quantity 3. Manufacturing Date Code 4. Caution



YDSCAM Package Solutions

Place Foam Sheets Between Tray Bags



Foam Sheets are Larger Than Trays



Place Foam Sheets and Trays into Box



Foam Sheets are Tightly Fitting in Box



Seal the Carbon Box



Label the Carbon Shipping Box





YDSCAM Package Solutions

USB Camera Module

Complete with Lens Protection Film



Place Camera Sample into Anti-Static Bag

Place USB Cameras into Tray



Seal the Tray with Anti-Static Bag

Label the Carbon Shipping Box



YDSCAM Package Solutions

Place Camera Sample into Anti-Static Bag



Place Connectors into Anti-Static Bag



Label the Sample Bags



Place Connectors into Reel



Place Samples into the Carbon Box



Place Connectors into the Carbon Box





YDS CAMERA MODULE

your best camera partner

Company YDSCAM

YingDeShun Co. Ltd. (YDS) was established in 2017, a next-generation technology driven manufacturer specialized in research, design, and produce of audio and video products. YDS is occupying 20,000 square feet automated plants with 100 employees of annual throughput 30,000,000 units cameras.

YDS provides OEM, ODM design, contract manufacturing, and builds the camera products. You may provide the requirements to us, even with a hand draft, our sales and engineering work together to meet your needs. We consider ourselves your last-term partner in developing practical and innovative solutions.

Our team covers everything from initial concept development to mass produced product. YDS specializes in customized camera design, raw material, electronic engineering, firmware/software development, product testing, and packing design. Our experienced strategic supply systems offer a robust and dependable manufacturing capacity for orders of various sizes.



Limited Warranty

YDS provides the following limited warranty if you purchased the Product(s) directly from YDS company or from YDS's website www.YDSCAM.com. Product(s) purchased from other sellers or sources are not covered by this Limited Warranty. YDS guarantees that the Product(s) will be free from defects in materials and workmanship under normal use for a period of one (1) year from the date you receive the product ("Warranty Period").

For all Product(s) that contain or develop material defects in materials or workmanship during the Warranty Period, YDS will, at its sole option, either: (i) repair the Product(s); (ii) replace the Product(s) with a new or refurbished Product(s) (replacement Product(s) being of identical model or functional equivalent); or (iii) provide you a refund of the price you paid for the Product(s).

This Limited Warranty of YDS is solely limited to repair and/or replacement on the terms set forth above. YDS is not reliable or responsible for any subsequent events.



www.YDSCAM.com sales@ydscom.com Phone (WeChat, QQ): (+86) 177 2732 6718

All rights reserved @ YingDeShun Co. Ltd. Specifications subject to change without notice.



YDS CAMERA MODULE

your best camera partner

YDS Strength

Powerful Factory



Professional Service



Promised Delivery



www.YDSCAM.com sales@ydscam.com Phone (WeChat, QQ): (+86) 177 2732 6718

All rights reserved @ YingDeShun Co. Ltd. Specifications subject to change without notice.